



INNOVATIVE DESIGNS
FOR CREATIVE SPACES®

Solid Wood Art Table with Laminate Top

Assembly Instructions

Tools Required for Assembly:

Tables: AT3060FM AT4260FM AT4272FM

- $\frac{3}{8}$ " Ratchet with $\frac{1}{2}$ " Socket & 3" Extension
- Flat Screwdriver

Included Hardware:

6 x $4\frac{1}{2}$ " Hex Bolts

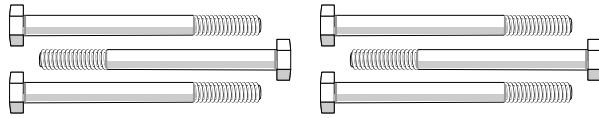

4 x $2\frac{3}{4}$ " Hex Bolts

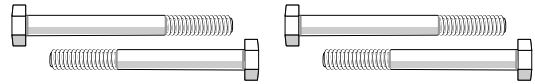

6 x Dowel Nuts



10 x Flat Washers



4 x Glides

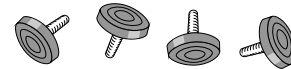

Wood Components:

2 x Top Supports

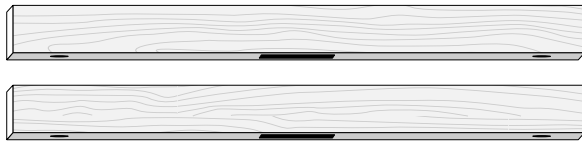

2 x Center Supports

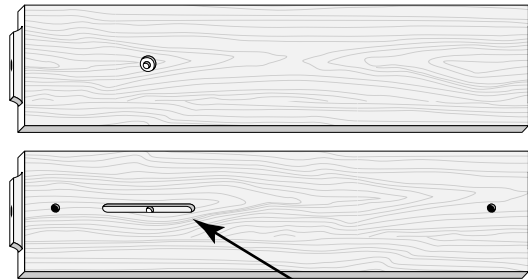

2 x Bottom Supports

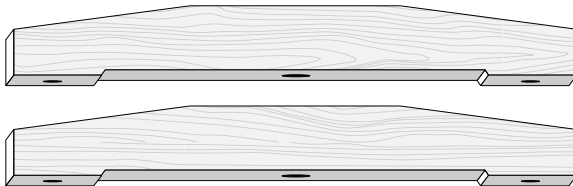

1 x Hardwood Top

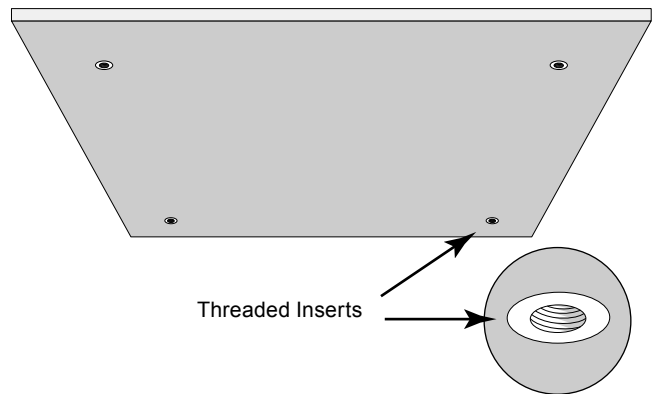

1 x Stretcher



LaminateTop Art Table

Assembly continued

Step 1. Leg Assembly:

A) Fit Top and Bottom Supports to the Center Support. Position the elongated slot toward the top.

Insert Dowel Nuts as shown. Use a screwdriver to align the Dowel Nuts, then thread 4½" Hex Bolts with Washers into the Dowel Nuts and tighten firmly.

Repeat for the second leg assembly.

B) Install Glides in the Bottom Supports.

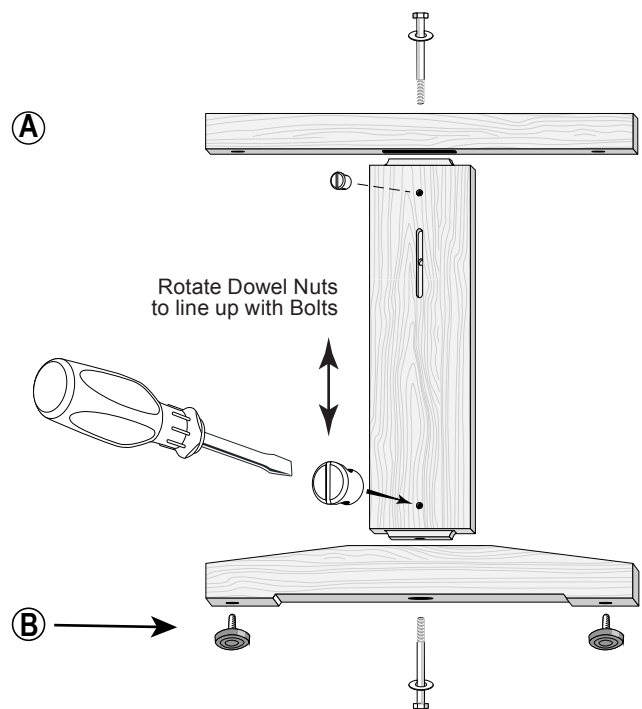

Step 2. Stretcher Assembly:

C) Fit Stretcher into the elongated slots in Center Supports. Insert Dowel Nuts and 4½" Bolts With Washers as shown. Do not fully tighten yet.

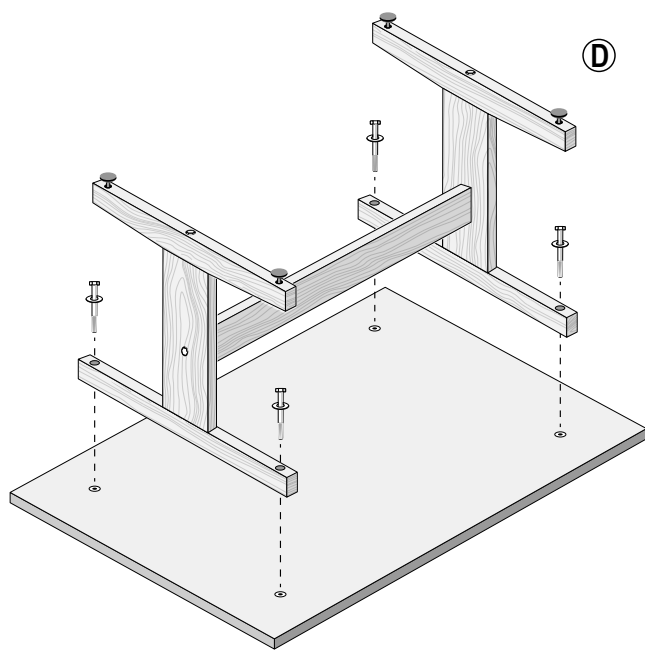
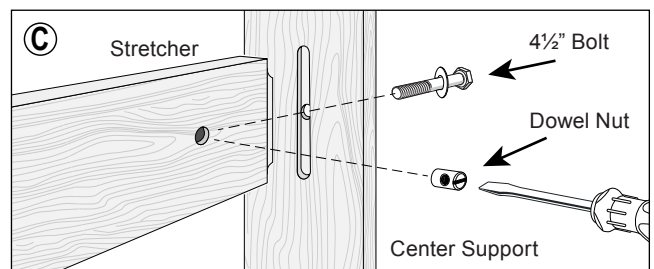

Step 3. Attach Laminate Top:

D) Lay Table Top upside-down on a clean surface. Position leg assembly by aligning bolt holes in the Top Support with the Threaded Inserts in Table Top.

Install 2¾" Hex Bolts and Washers. Fasten loosely.

When all four bolts are installed, fully tighten the bolts holding the Table Top, then the bolts attaching the Stretcher to the Leg Assemblies.

With a helper, turn the table upright and enjoy your new Art Table!



INNOVATIVE DESIGNS
FOR CREATIVE SPACES.

Solid Wood Art Table with Hardwood Top

Assembly Instructions

Tools Required for Assembly:

Tables: AT4260HM AT7272HM

- $\frac{3}{8}$ " Ratchet with $\frac{1}{2}$ " Socket & 3" Extension
- Flat Screwdriver

Included Hardware:

6 x $4\frac{1}{2}$ " Hex Bolts

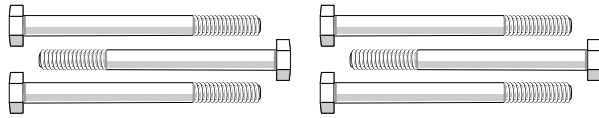

4 x 3" Lag Screws

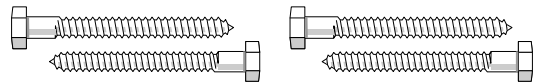

6 x Dowel Nuts



10 x Flat Washers

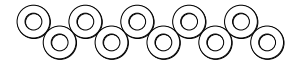

4 x Glides

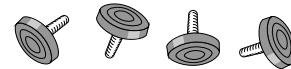

Wood Components:

2 x Top Supports

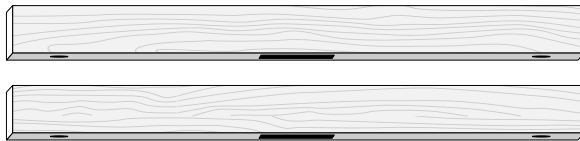

2 x Center Supports

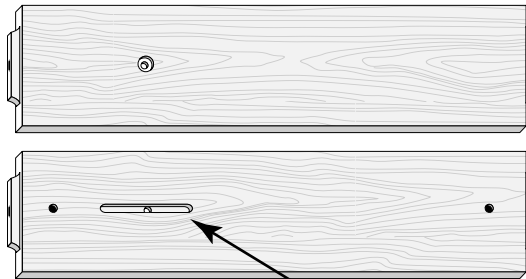

Elongated Slot

2 x Bottom Supports

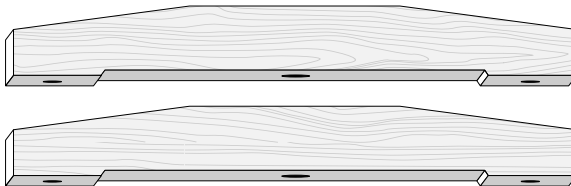

1 x Hardwood Top

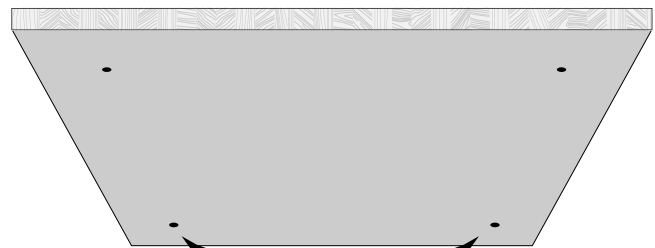

Pre-Drilled
Pilot Holes

1 x Stretcher



Hardwood Top Art Table

Assembly continued

Step 1. Leg Assembly:

A) Fit Top and Bottom Supports to the Center Support. Position the elongated slot toward the top.

Insert Dowel Nuts as shown. Use a screwdriver to align the Dowel Nuts, then thread 4½" Hex Bolts with Washers into the Dowel Nuts and tighten firmly.

Repeat for the second leg assembly.

B) Install Glides in the Bottom Supports.

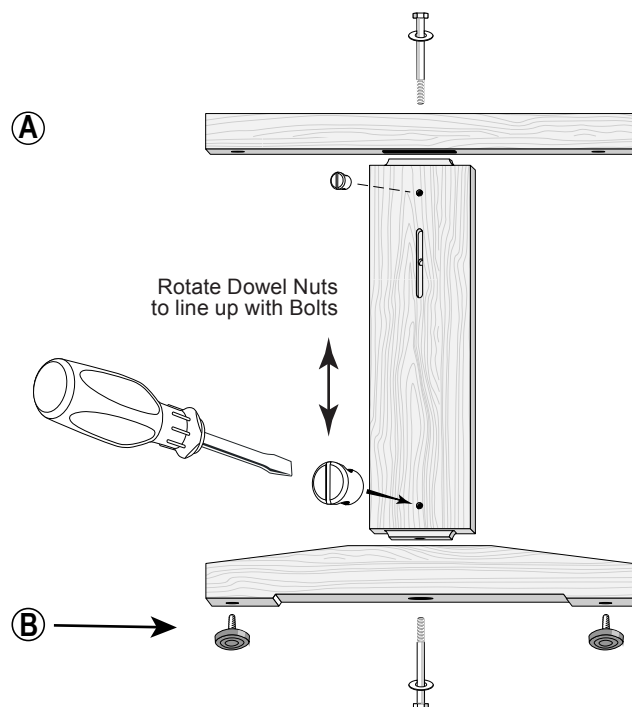

Step 2. Stretcher Assembly:

C) Fit Stretcher into the elongated slots in Center Supports. Insert Dowel Nuts and 4½" Bolts With Washers as shown. Do not fully tighten yet.

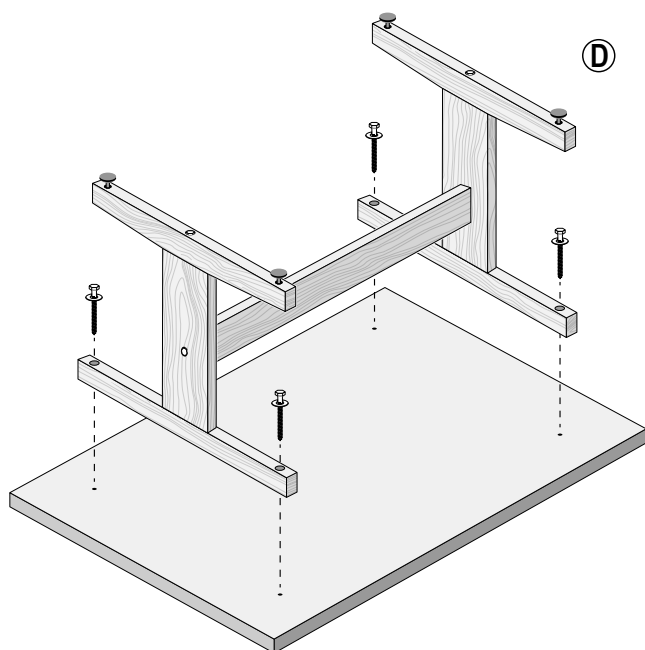
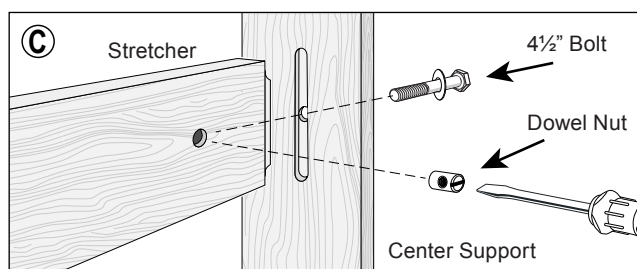

Step 3. Attach Hardwood Top:

D) Lay Table Top upside-down on a clean surface. Position leg assembly by aligning bolt holes in the Top Support with the Pre-drilled Holes in Table Top.

Install 3" Lag Screws and Washers. Fasten loosely.

When all four screws are installed, fully tighten the screws holding the Table Top, then the bolts attaching the Stretcher to the Leg Assemblies.

With a helper, turn the table upright and enjoy your new Art Table!